



**UNI-ROYAL**  
厚聲集團

# DATA SHEET

**Product Name** Chip Resistors Array

**Part Name** 2F01/4F01/2C02/4C02/2D02/4D02/2D03/4C03/4D03/4DP3/16P8 Series

## Uniroyal Electronics Global Co., Ltd.

88 Longteng Road, Economic & Technical Development Zone, Kunshan, Jiangsu, China

Tel +86 512 5763 1411 / 22 /33

Email [marketing@uni-royal.cn](mailto:marketing@uni-royal.cn)

Manufacture Plant Uniroyal Electronics Industry (kunshan) co., ltd.  
Uniroyal Electronics Industry Co., Ltd.  
Uniroyal Electronics Global Co.,Ltd Shenzhen Branch  
Aeon Technology Corporation  
Uniroyal Electronics Global Co.,Ltd Xiamen Branch  
Kunshan Foss Electronic material Co., Ltd.  
Royal Electronic Factory (thailand) co., ltd

Brands *RoyalOhm* *UniOhm*



## 1. Scope

- 1.1 This specification for approve relates to chip resistors array manufactured by UNI-ROYAL.
- 1.2 High density, more than 1 resistors in one small case
- 1.3 Improvement of placement efficiency
- 1.4 Tape/Reel packaging is suitable for automatic placement machine
- 1.5 Superior solderability
- 1.6 Application: Master board, CD&DVD Rom, Hard Disk, RAM

## 2. Part No. System

Part No. includes 14 codes shown as below:

2.1 1<sup>st</sup>~4<sup>th</sup> codes: Part name. E.g.: 2D02,4D02,2D03,4D03,4DP3,16P8,2C02, 4C02, 4C03,2F01,4F01.

2.2 5<sup>th</sup>~6<sup>th</sup> codes: Power rating.

E.g.: W=Normal Size "1~G" = "1~16"

Wattage	1/32	3/4	1/2	1/3	1/4	1/8	1/10	1/16	1/20	1
Normal Size	WH	07	W2	W3	W4	W8	WA	WG	WM	1W

If power rating is lower or equal than 1 watt, 5<sup>th</sup> code would be "W" and 6<sup>th</sup> code would be a number or letter.

E.g.: WA=1/10W W4=1/4W

2.3 7<sup>th</sup> code: Tolerance. E.g.: D=±0.5% F=±1% G=±2% J=±5% K= ±10%

2.4 8<sup>th</sup>~11<sup>th</sup> codes: Resistance Value.

2.4.1 If value belongs to standard value of ≥5% series, 8<sup>th</sup> code would be zero, 9<sup>th</sup>~10<sup>th</sup> codes are significant figures of the resistance and 11<sup>th</sup> code is the power of ten.

2.4.2 If value belongs to standard value of ≤2% series, 8<sup>th</sup>~10<sup>th</sup> codes are significant figures of the resistance, and 11<sup>th</sup> code is the power of ten.

2.4.3 11<sup>th</sup> codes listed as following:

0=10<sup>0</sup> 1=10<sup>1</sup> 2=10<sup>2</sup> 3=10<sup>3</sup> 4=10<sup>4</sup> 5=10<sup>5</sup> 6=10<sup>6</sup> J=10<sup>-1</sup> K=10<sup>-2</sup> L=10<sup>-3</sup> M=10<sup>-4</sup>

2.5 12<sup>th</sup>~14<sup>th</sup> codes.

2.5.1 12<sup>th</sup> code: Packaging Type. E.g.: C=Bulk T=Tape/Reel

2.5.2 13<sup>th</sup> code: Standard Packing Quantity.

4=4000pcs 5=5000pcs C=10000pcs D=20000pcs E=15000pcs

Chip Product: BD=B/B-20000pcs TC=T/R-10000pcs

2.5.3 14<sup>th</sup> code: Special features.

E = Environmental Protection, Lead Free, or Standard type.

## 3. Ordering Procedure

(Example: 4C02 1/16W ±5% 100 Ω T/R-10000 )

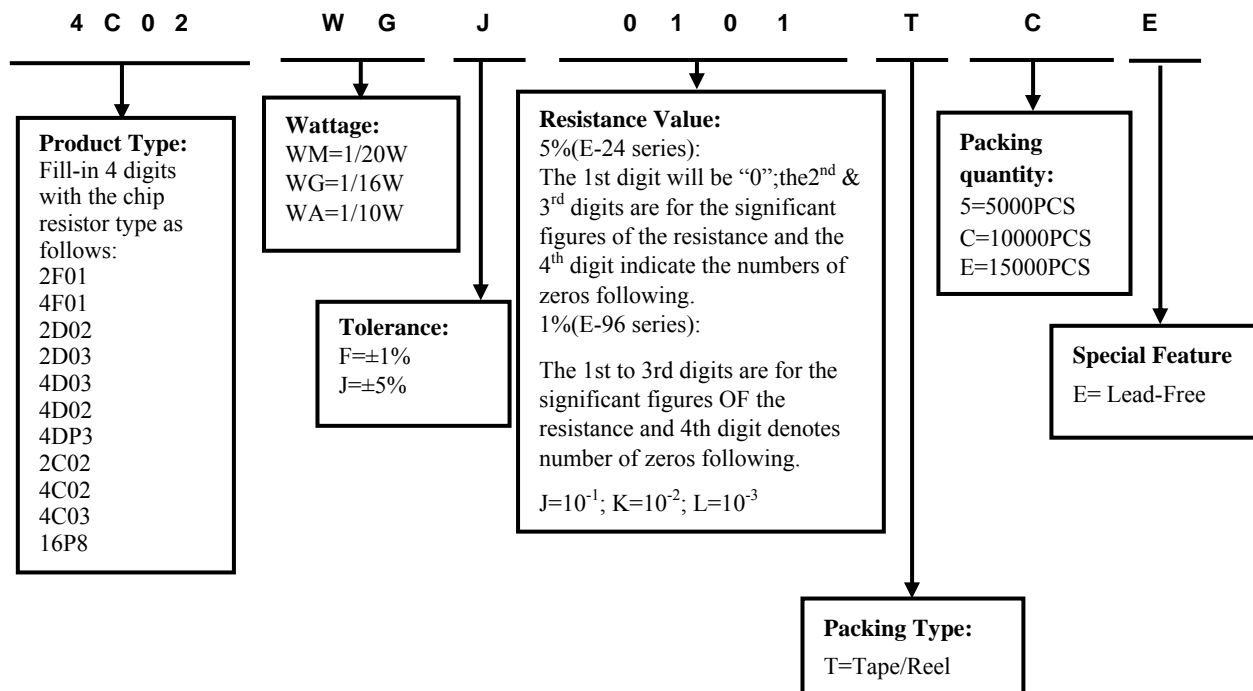

**4. Marking**

(1) Normal for 2D02 & 2C02 & 4C02 size, no marking on the body, 0Ω resistors is no marking too.

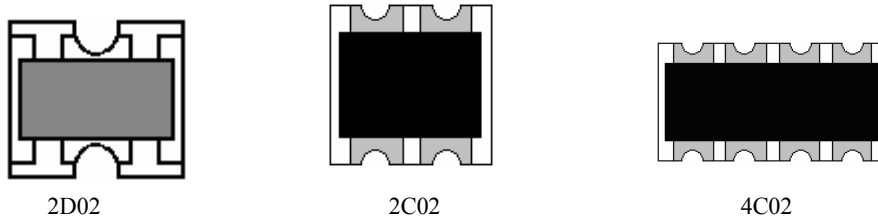

(2) ±5% Tolerance of 4D02, 2D03, 4D03, 4DP3, 4C03 and 16P8 size: the first two digits are significant figures of resistance and the third denotes number of zeros following .

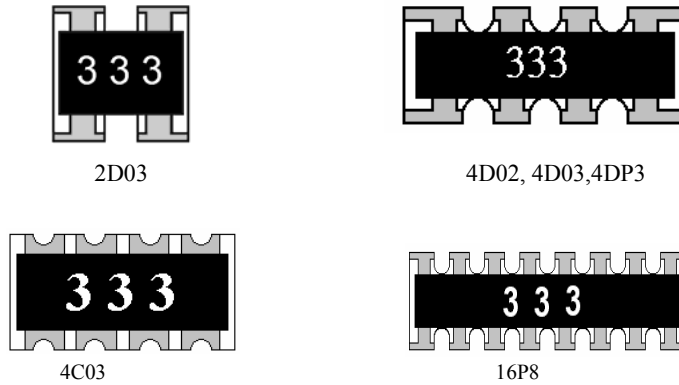

(3) ±1% Tolerance of 2D03, 4D02, 4D03, 4DP3, 4C03 and 16P8 size: first three digits are significant figures of resistance and the fourth denotes number of zeros following

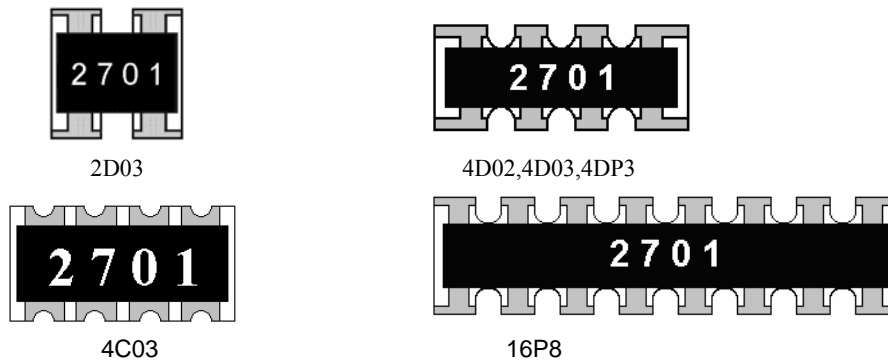

(4) 0Ω : Normal of 2D03, 4D02, 4D03, 4C03, 16P8 size, the marking as following:

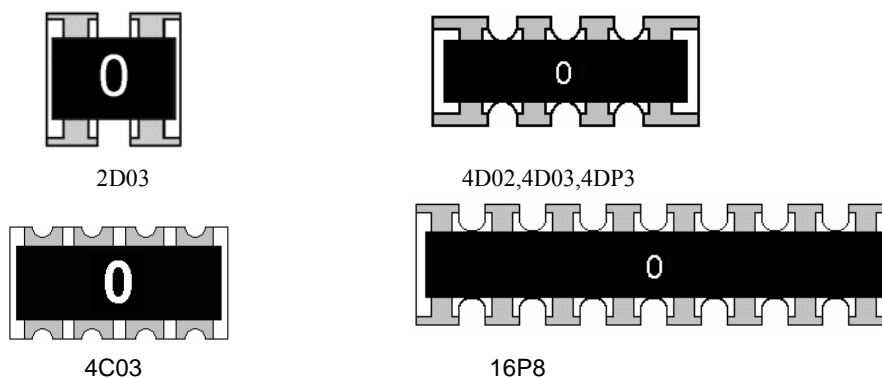

(5) Normal for 2F01, 4F01 sizes, no marking on the body. 0Ω resistors is no marking too



## 5. Dimension

### 5.1 Equivalent Circuit Diagram:

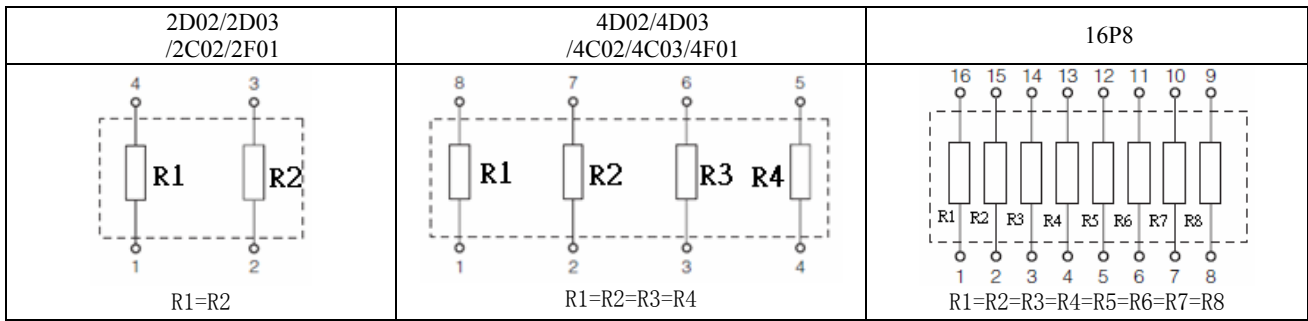

### 5.2 Dimensions in mm:

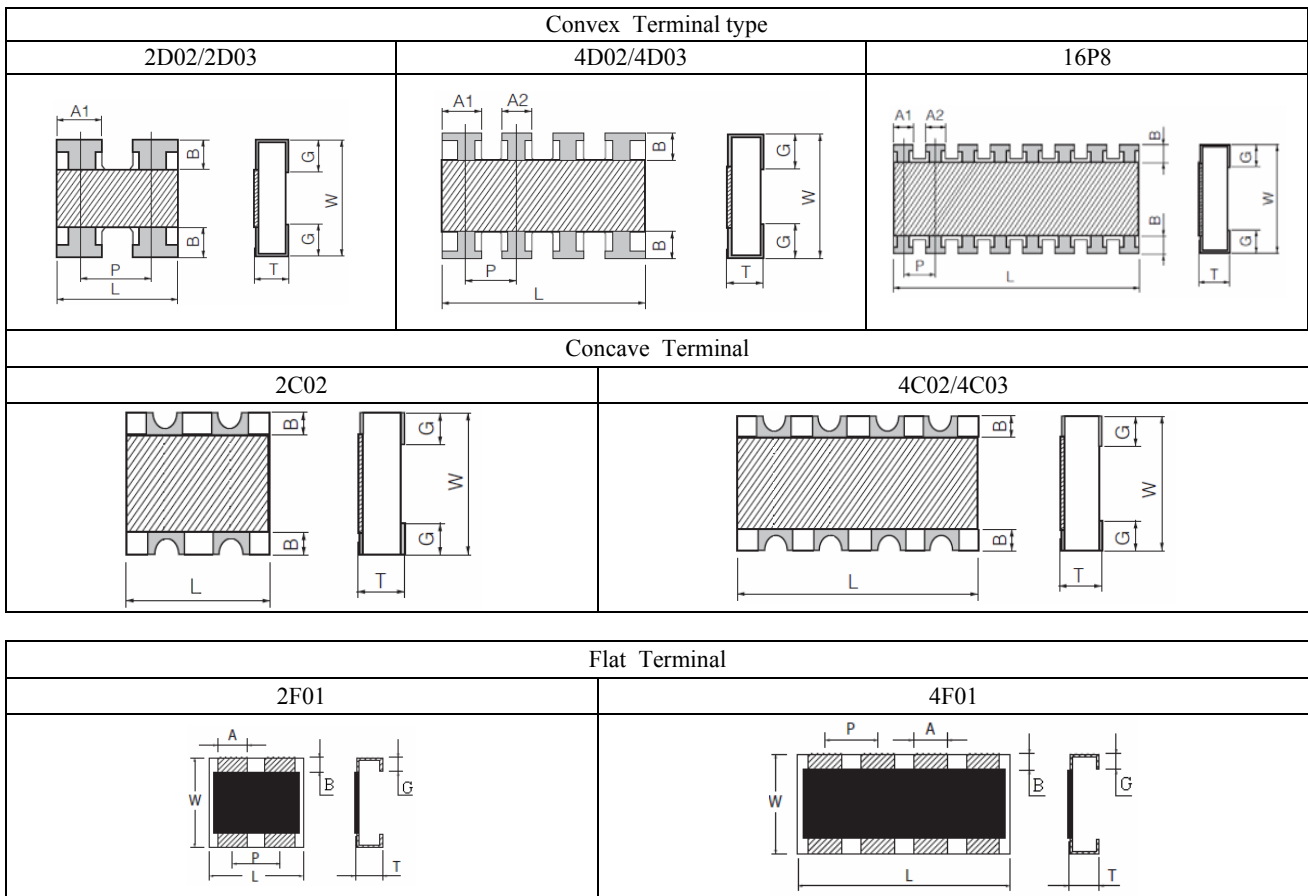

Type	Dimensions (mm)							
	L	W	T	A1	A2	B	P	G
2D02(0402*2)	1.00±0.10	1.00±0.10	0.35±0.10	0.33±0.10	/	0.15±0.05	0.65±0.05	0.25±0.10
4D02(0402*4)	2.00±0.10	1.00±0.10	0.45±0.10	0.40±0.05	0.30±0.05	0.20±0.15	0.50±0.05	0.30±0.15
2D03(0603*2)	1.60±0.15	1.60±0.15	0.50±0.10	0.60±0.15	/	0.30±0.10	0.80±0.05	0.25±0.10
4D03/4DP3(0603*4)	3.20±0.20	1.60±0.20	0.50±0.10	0.65±0.15	0.50±0.15	0.30±0.15	0.80±0.10	0.30±0.15
16P8	4.00±0.20	1.60±0.15	0.45±0.10	0.45±0.05	0.30±0.05	0.30±0.15	0.50±0.05	0.40±0.15
2C02(0402*2)	1.00±0.10	1.00±0.10	0.35±0.10	/	/	0.15±0.10	/	0.30±0.10
4C02(0402*4)	2.00±0.10	1.00±0.10	0.45±0.10	/	/	0.15±0.10	/	0.30±0.10
4C03(0603*4)	3.20±0.20	1.60±0.20	0.60±0.10	/	/	0.30±0.20	/	0.40±0.10
2F01(0201*2)	0.80±0.10	0.60±0.10	0.35±0.10	0.30±0.10	/	0.15±0.10	0.50±0.05	0.15±0.10
4F01(0201*4)	1.40±0.10	0.60±0.10	0.35±0.10	0.20±0.10	/	0.15±0.10	0.40±0.05	0.15±0.10

## 6. Resistance Range

Type	Rated power 70°C	Max Working Voltage	Max Overload Voltage	Dielectric Withstanding Voltage	Resistance Range ±5%±1%	Temperature Coefficient PPM/°C	Operating Temperature	Resistance Value of Jumper	Rated Current of Jumper
2D02	1/16W	50V	100V	100V	10Ω~1MΩ	±200	-55°C~+155°C	<50mΩ	1A
4D02	1/16W	50V	100V	100V	10Ω~1MΩ	±200			
2D03	1/16W	50V	100V	100V	10Ω~1MΩ	±200			
4D03	1/16W	50V	100V	300V	1Ω~1MΩ	≥10Ω:±200 <10Ω:±400			
4DP3	1/10W	50V	100V	300V	1Ω~1MΩ	≥10Ω:±200 <10Ω:±400			
16P8	1/16W	50V	100V	300V	1Ω~1MΩ	≥10Ω:±200 <10Ω:±400			
2C02	1/16W	50V	100V	100V	10Ω~1MΩ	±200			
4C02	1/16W	50V	100V	100V	10Ω~1MΩ	±200			
4C03	1/10W	50V	100V	300V	1Ω~1MΩ	≥10Ω:±200 <10Ω:±400	-55°C~+125°C	<50mΩ	1A
2F01	1/20W	12.5V	25V	/	10Ω~1MΩ	±200			
4F01	1/20W	12.5V	25V	/	10Ω~1MΩ	±200			

## 7. Recommend the size of welding plate

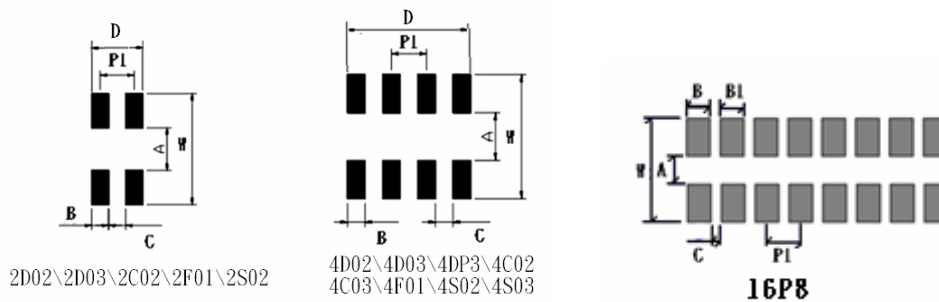

Type	Dimension(mm)							
	A	B	B1	B2	W	C	P1	D
2D02	0.5±0.1	0.33±0.1	/	/	2.0±0.1	0.34±0.1	/	1.0±0.1
4D02	0.5±0.1	0.3±0.1	0.28±0.1	0.28±0.1	2.0±0.1	0.22±0.1	/	1.82±0.1
2D03	0.8±0.1	0.45±0.05	/	/	2.6±0.2	0.35±0.05	0.8±0.05	/
4D03	1.0±0.1	0.4±0.1	0.4±0.1	0.4±0.1	2.6±0.1	0.4±0.1	/	2.8±0.1
4DP3	1.0±0.1	0.4±0.1	0.4±0.1	0.4±0.1	2.6±0.1	0.4±0.1	/	2.8±0.1
16P8	1.0±0.1	0.3±0.1	0.3±0.1	/	2.3±0.1	0.2±0.1	0.5±0.1	/
2C02	0.5±0.1	0.3±0.1	/	/	2.0±0.1	0.2±0.1	/	0.8±0.1
4C02	0.5±0.1	0.3±0.1	0.3±0.1	0.3±0.1	2.0±0.1	0.2±0.1	/	1.8±0.1
4C03	1.0±0.1	0.4±0.1	0.4±0.1	0.4±0.1	2.6±0.1	0.4±0.1	/	2.8±0.1
2F01	0.3±0.1	0.3±0.05	/	/	0.9±0.2	0.2±0.05	0.5±0.05	/
4F01	0.3±0.1	0.2±0.05	/	/	0.9±0.2	0.2±0.05	0.45±0.05	/

## 8. Derating Curve

Resistors shall have a power rating based on continuous load operation at an ambient temperature from -55°C to 70°C. For temperature in excess of 70°C, the load shall be derate as shown in figure 1

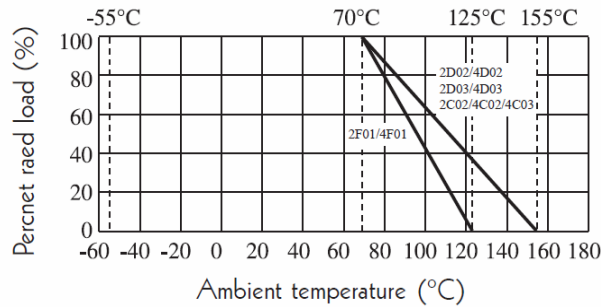

### 8.1 Voltage rating:

Resistors shall have a rated direct-current (DC) continuous working

Voltage or an approximate sine-wave root-mean-square (RMS) alternating-current (AC) continuous working voltage at commercial-line frequency and waveform corresponding to the power rating, as determined from the following formula:

$$RCWV = \sqrt{P \times R}$$

Where: RCWV commercial-line frequency and waveform (Volt.)

P = power rating (WATT.)

R = nominal resistance (OHM)

The overload voltage is 2.5 times RCWV or Max. Overload voltage whichever is less.

In no case shall the rated DC or RMS AC continuous working voltage be greater than the applicable maximum value.

## 9. Structure

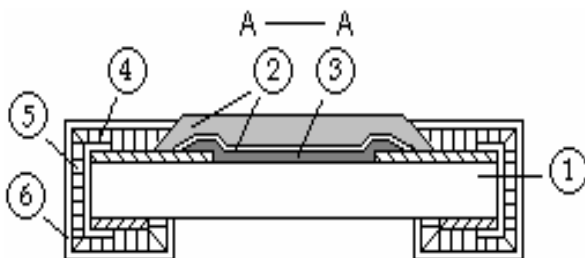

- 1: High purity alumina substrate
- 2: Protective covering
- 3: Resistive covering
- 4: Termination (inner) Ag/Pd
- 5: Termination (between) Ni plating
- 6: Termination (outer) Sn plating

## 10. Performance Specification

Characteristic	Limits	Test Methods (GB/T5729&JIS-C-5201&IEC60115-1)
Temperature Coefficient	Reference 6.	4.8 Natural resistance changes per temp. Degree centigrade $\frac{R_2 - R_1}{R_1(t_2 - t_1)} \times 10^6 \text{ (PPM/°C)}$ $R_1(t_2 - t_1)$ R <sub>1</sub> : Resistance Value at room temperature (t <sub>1</sub> ); R <sub>2</sub> : Resistance at test temperature (Upper limit temperature or Lower limit temperature) t <sub>1</sub> : +25°C or specified room temperature t <sub>2</sub> : Upper limit temperature or Lower limit temperature test temperature
*Short-time overload	±(2.0%+0.1Ω) 2F01: 1%:±1.0%+0.05Ω 5%:±2.0%+0.05Ω * ΔR<50mΩ	4.13 Permanent resistance change after the application of 2.5 times RCWV for 5 seconds. Apply max overload current for 0Ω

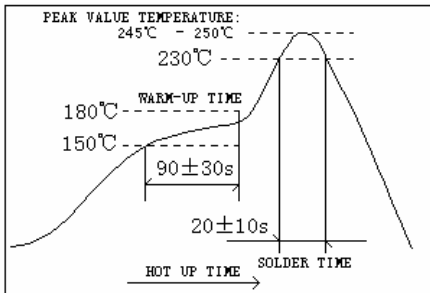
* Insulation resistance	$\geq 1,000 \text{ M}\Omega$	4.6 the measuring voltage shall be measured with a direct voltage of $(100\pm 15)\text{V}$ or a voltage equal to the dielectric withstanding voltage., and apply for 1min
Terminal bending	$\pm(1.0\%+0.05\Omega)$	4.33 Twist of test board: $Y/x = 3/90 \text{ mm}$ for 60Seconds
* Dielectric withstanding voltage	No evidence of flashover mechanical damage, arcing or insulation breaks down.	4.7 Resistors shall be clamped in the trough of a $90^\circ\text{C}$ metallic v-block and shall be tested at ac potential respectively specified in the given list of each product type for 60-70 seconds.
Soldering heat	Resistance change rate is: $\pm(1.0\%+0.05\Omega)$	4.18 Dip the resistor into a solder bath having a temperature of $260^\circ\text{C}\pm 5^\circ\text{C}$ and hold it for $10\pm 1$ seconds.
*Solderability	Coverage must be over 95%.	Wave solder: Test temperature of solder: $245^\circ\text{C}\pm 3^\circ\text{C}$ dipping time in solder: 2-3 seconds.
	Go up tin rate bigger than half of end pole	Reflow: 
Rapid change of temperature	$\pm(1.0\%+0.05\Omega)$ 2F01: 1%: $\pm 0.5\%+0.05\Omega$ 5%: $\pm 1.0\%+0.05\Omega$	4.19 30 min at lower limit temperature and 30 min at upper limit temperature , 100 cycles.
*Load life in humidity	$\pm(3.0\%+0.1\Omega)$ 2F01: 1%: $\pm 2.0\%+0.1\Omega$ 5%: $\pm 3.0\%+0.1\Omega$	7.9 Resistance change after 1,000 hours (1.5 hours "ON",0.5 hour "OFF") at RCWV in a humidity chamber controlled at $40^\circ\text{C}\pm 2^\circ\text{C}$ and 90 to 95% relative humidity.
	* $\Delta R < 50\text{m}\Omega$	Apply to rated current for $0\Omega$
*Load life	$\pm(3.0\%+0.1\Omega)$ 2F01: 1%: $\pm 2.0\%+0.1\Omega$ 5%: $\pm 3.0\%+0.1\Omega$	4.25.1 Permanent resistance change after 1,000 hours operating at RCWV with duty cycle 1.5 hours "ON",0.5 hour "OFF", at $70^\circ\text{C}\pm 2^\circ\text{C}$ ambient.
	* $\Delta R < 50\text{m}\Omega$	Apply to rated current for $0\Omega$
*Low Temperature Storage	$\pm(3.0\%+0.1\Omega)$ 2F01: 1%: $\pm 2.0\%+0.1\Omega$ 5%: $\pm 3.0\%+0.1\Omega$	4.23.4 Lower limit temperature, for 2H.
	* $\Delta R < 50\text{m}\Omega$	Apply to rated current for $0\Omega$
*High Temperature Exposure	$\pm(3.0\%+0.1\Omega)$ 2F01: 1%: $\pm 2.0\%+0.1\Omega$ 5%: $\pm 3.0\%+0.1\Omega$	4.23.2 Upper limit temperature , for 16H.
	* $\Delta R < 50\text{m}\Omega$	Apply to rated current for $0\Omega$
*Leaching	No visible damage	J-STD-002 Test D Samples completely immersed for 30 sec in solder bath at $260^\circ\text{C}$

The resistors of  $0\Omega$  only can do the characteristic noted of \*

## 11. Packing of Surface Mount Resistors

11.1 Dimension of Paper Taping : (Unit: mm)

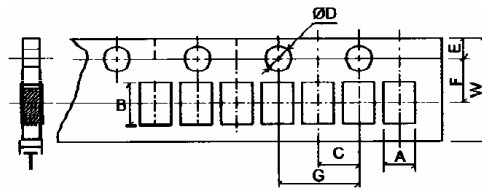

Type	A ±0.2	B ±0.2	C ±0.05	ØD +0.1 -0	E ±0.1	F ±0.05	G ±0.1	W ±0.2	T ±0.1
2D02/2C02	1.20	1.20	2.00	1.50	1.75	3.50	4.00	8.00	0.45
4D02/4C02	1.20	2.20	2.00	1.50	1.75	3.50	4.00	8.00	0.70
2F01	0.79	1.00	2.00	1.50	1.75	3.50	4.00	8.00	0.50
4F01	0.90	1.70	2.00	1.50	1.75	3.50	4.00	8.00	0.50

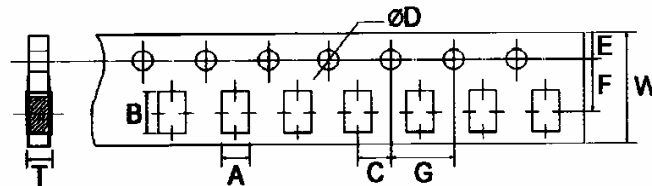

Type	A ±0.2	B ±0.2	C ±0.05	ØD +0.1 -0	E ±0.1	F ±0.05	G ±0.1	W ±0.2	T ±0.1
4D03/4DP3/4C03	2.00	3.60	2.00	1.50	1.75	3.50	4.00	8.00	0.83
2D03	1.90	1.90	2.00	1.50	1.75	3.50	4.00	8.00	0.83
16P8	1.80	4.30	2.00	1.50	1.75	5.50	4.00	12.00	0.75

11.3 Dimension of Reel : (Unit: mm)

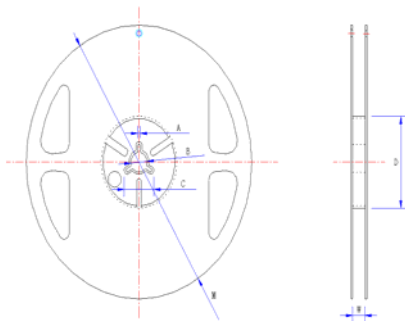

TYPE	Qty/Reel	A ± 0.5	B ± 0.5	C ± 0.5	D ± 1.0	M ± 2.0	W ± 1.0
2D02	10,000PCS	2.0	13.0	21.0	60.0	178.0	10.0
4D02	10,000PCS	2.0	13.0	21.0	60.0	178.0	10.0
2D03	5,000PCS	2.0	13.0	21.0	60.0	178.0	10.0
4D03	5,000PCS	2.0	13.0	21.0	60.0	178.0	10.0
4DP3	5,000PCS	2.0	13.0	21.0	60.0	178.0	10.0
16P8	4,000PCS	2.0	13.0	21.0	60.0	178.0	13.8
2C02	10,000PCS	2.0	13.0	21.0	60.0	178.0	10.0
4C02	10,000PCS	2.0	13.0	21.0	60.0	178.0	10.0
4C03	5,000PCS	2.0	13.0	21.0	60.0	178.0	10.0
2F01	15,000PCS	2.0	13.0	21.0	60.0	178.0	10.0
4F01	15,000PCS	2.0	13.0	21.0	60.0	178.0	10.0



## 12. Note

12.1 UNI-ROYAL recommend the storage condition temperature: 15°C~35°C, humidity :25%~75%.

(Put condition for individual product)

Even under UNI-ROYAL recommended storage condition, solderability of products over 1 year old. (Put condition for each product) may be degraded.

12.2 Store / transport cartons in the correct direction, which is indicated on a carton as a symbol.

Otherwise bent leads may occur due to excessive stress applied when dropping of a carton.

12.3 Product performance and soldered connections may deteriorate if the products are stored in the following places:

- a. Storage in high Electrostatic
- b. Storage in direct sunshine、rain and snow or condensation
- c. Where the products are exposed to sea winds or corrosive gases, including Cl<sub>2</sub>, H<sub>2</sub>S, NH<sub>3</sub>, SO<sub>2</sub>, NO<sub>2</sub>.

## 13. Record

Version	Description of amendment	Page	Date	Amended by	Checked by
1	First issue of this specification	1~9	Mar.20, 2018	Chen Haiyan	Chen Nana
2	Modify 2F01,4F01 packing quantity	8	Jun.06, 2018	Chen Haiyan	Chen Nana
3	Modify the Performance Specification	6~7	Feb.18, 2019	Chen Haiyan	Xu Yuhua

Uniroyal Electronics Global Co., Ltd. , all rights reserved. Spec. herein would be changed at any time without prior notice.